

# i3PROJECTOR



i3PROJECTOR 3303W UM USER MANUAL



Table of Contents.....	2	Multimedia.....	41
Usage Notice .....	3	<i>Accessing Multimedia Files.....</i>	41
<i>Safety Information.....</i>	3	<i>How to access Multimedia mode .....</i>	41
<i>Precautions.....</i>	4	<i>Replace the Lamp .....</i>	48
Introduction.....	6	Appendices .....	50
<i>Package Overview .....</i>	6	<i>Installing and Cleaning the Optional</i>	
<i>Product Overview.....</i>	7	<i>Dust Filter.....</i>	50
<i>Main Unit .....</i>	7	<i>Compatibility Modes.....</i>	51
<i>Control Panel.....</i>	8	VGA Analog.....	51
<i>Interface .....</i>	9	HDMI Digital.....	53
<i>Remote Control.....</i>	10	<i>RS232 Commands and Protocol</i>	
Installation .....	11	<i>Function List .....</i>	55
<i>Connecting the Projector.....</i>	11	<i>RS232 Port Setting.....</i>	55
<i>Connect a Desktop/Laptop Computer</i>	11	<i>RS232 Signals Connection.....</i>	55
<i>Connect to Video Sources.....</i>	12	<i>Commands Set List .....</i>	56
<i>Powering the Projector On / Off.....</i>	13	<i>List of specifications.....</i>	59
<i>Powering On the Projector .....</i>	13	<i>Wall Mount Installation.....</i>	61
<i>Powering Off the Projector.....</i>	14	<i>Regulation &amp; Safety Notices.....</i>	62
<i>Warning Indicator .....</i>	14		
<i>Adjusting the Projected Image.....</i>	15		
<i>Adjusting the Projector's Height .....</i>	15		
<i>Adjusting the Projector's Focus.....</i>	16		
<i>Adjusting Projection Image Size</i>			
<i>(Diagonal).....</i>	17		
User Controls .....	19		
<i>Control Panel &amp; Remote Control.....</i>	19		
<i>Control Panel.....</i>	19		
<i>Remote Control.....</i>	20		
<i>On-screen Display Menus .....</i>	22		
<i>How to operate .....</i>	22		
<i>Picture .....</i>	23		
<i>Screen.....</i>	25		
<i>Setting.....</i>	27		
<i>Volume .....</i>	29		
<i>Options.....</i>	30		
<i>Options   Lamp Settings .....</i>	32		
<i>3D.....</i>	33		
<i>Interactive .....</i>	34		
<i>LAN.....</i>	35		

# Usage Notice

## Safety Information

	The lightning flash with arrow head within an equilateral triangle is intended to alert the user to the presence of uninsulated "dangerous voltage" within the product's enclosure that may be of sufficient magnitude to constitute a risk of electric shock to persons.
	The exclamation point within an equilateral triangle is intended to alert the user to the presence of important operating and maintenance (servicing) instructions in the literature accompanying the appliance.

**WARNING:** TO REDUCE THE RISK OF FIRE OR ELECTRIC SHOCK, DO NOT EXPOSE THIS APPLIANCE TO RAIN OR MOISTURE. DANGEROUS HIGH VOLTAGES ARE PRESENT INSIDE THE ENCLOSURE. DO NOT OPEN THE CABINET. REFER SERVICING TO QUALIFIED PERSONNEL ONLY.

### **Class B emissions limits**

This Class B digital apparatus meets all requirements of the Canadian Interference-Causing Equipment Regulations.

### **Important Safety Instruction**

1. Do not block any ventilation openings. To ensure reliable operation of the projector and to protect from over heating, it is recommended to install the projector in a location that does not block ventilation. As an example, do not place the projector on a crowded coffee table, sofa, bed, etc. Do not put the projector in an enclosure such as a book case or a cabinet that restricts air flow.
2. Do not use the projector near water or moisture. To reduce the risk of fire and/or electric shock, do not expose the projector to rain or moisture.
3. Do not install near heat sources such as radiators, heaters, stoves or any other apparatus such as amplifiers that emits heat.
4. Clean only with dry cloth.
5. Only use attachments/accessories specified by the manufacturer.
6. Do not use the unit if it has been physically damaged or abused. Physical damage/abuse would be (but not limited to):
  - Unit has been dropped.
  - Power supply cord or plug has been damaged.
  - Liquid has been spilled on to the projector.
  - Projector has been exposed to rain or moisture.
  - Something has fallen in the projector or something is loose inside.Do not attempt to service the unit yourself. Opening or removing covers may expose you to dangerous voltages or other hazards.
7. Do not let objects or liquids enter the projector. They may touch dangerous voltage points and short out parts that could result in fire or electric shock.
8. The unit should only be repaired by appropriate service personnel.

# Precautions



*Please follow all warnings, precautions and maintenance as recommended in this user's guide.*

- Warning- Do not look into the projector's lens when the lamp is on. The bright light may hurt and damage your eyes.
- Warning- To reduce the risk of fire or electric shock, do not expose this projector to rain or moisture.
- Warning- Please do not open or disassemble the projector as this may cause electric shock.
- Warning- Before replacing the lamp, please have the projector completely cooled down. Operate as described on Pages 48-49.
- Warning- This projector will automatically detect the service life of its lamp. When the projector shows a warning message, the lamp must be replaced "immediately".
- Warning- After replacement of the lamp module, please reset the lamp hour counter (see Page 49).
- Warning- When switching the projector off, please ensure the cooling cycle has been completed before disconnecting power. Allow 90 seconds for the projector to cool down.
- Warning- When service life of the lamp is about to expire, the "Lamp Warning: Exceed Service Life" message will be shown on the screen. Please contact the local dealer or service center to replace the lamp as soon as possible.



❖ When service life of the lamp expires, the lamp module must be replaced. Otherwise, the projector cannot be switched on. To replace the lamp, please follow the steps stated in "Replace the Lamp" on Pages 48-49.

# Usage Notice

## **Do:**

- ❖ Turn off and unplug the power plug from the AC outlet before cleaning the product.
- ❖ Use a soft dry cloth with mild detergent to clean the display housing.
- ❖ Disconnect the power plug from AC outlet if the product is not being used for a long period of time.

## **Do not:**

- ❖ Block the slots and openings on the unit provided for ventilation.
- ❖ Use abrasive cleaners, waxes or solvents to clean the unit.
- ❖ Do not use under the following conditions:
  - In extremely hot, cold or humid environments.
    - ▶ Ensure that the ambient room temperature is within 5 - 40°C.
    - ▶ Relative Humidity is 5 - 40°C, 80% (Max.), non-condensing.
  - In areas susceptible to excessive dust and dirt.
  - Near any appliance generating a strong magnetic field.
  - In direct sunlight.

# Package Overview

*Unpack and inspect the box contents to ensure all parts listed below are in the box. If something is missing, please contact your nearest customer service center.*

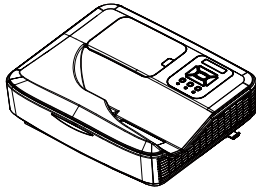

Projector

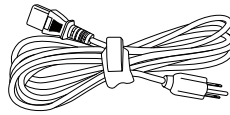

Power Cord

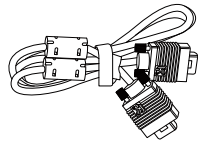

VGA Cable (\*)

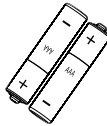

2 × AAA Batteries



IR Remote Control



CD-ROM  
(User's Manual)



❖ Due to different applications in each country, some regions may have different accessories.

# Introduction

## Product Overview

### Main Unit

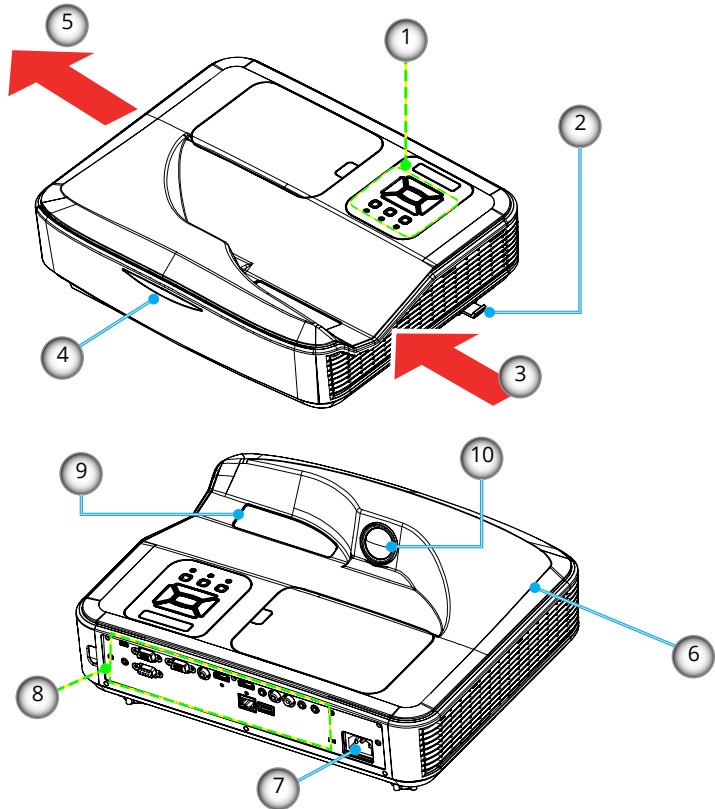

❖ The interface is subject to model's specifications.

- |                         |                               |
|-------------------------|-------------------------------|
| 1. Control Panel        | 6. Speaker                    |
| 2. Focus Switch         | 7. Power Socket               |
| 3. Ventilation (inlet)  | 8. Input / Output Connections |
| 4. IR Receiver          | 9. Lens                       |
| 5. Ventilation (outlet) | 10. IR Camera                 |

## Control Panel

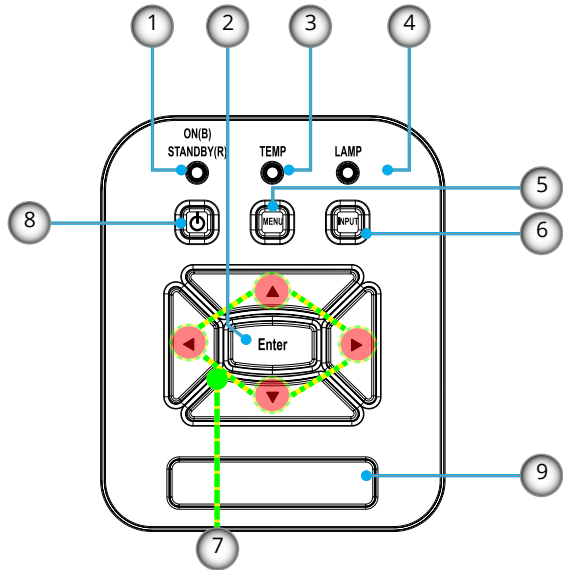

1. Power LED
2. Enter
3. Temp LED
4. Lamp LED
5. Menu
6. Signal source
7. Four Directional Select Keys
8. Power/Standby button
9. IR Receiver



## Interface

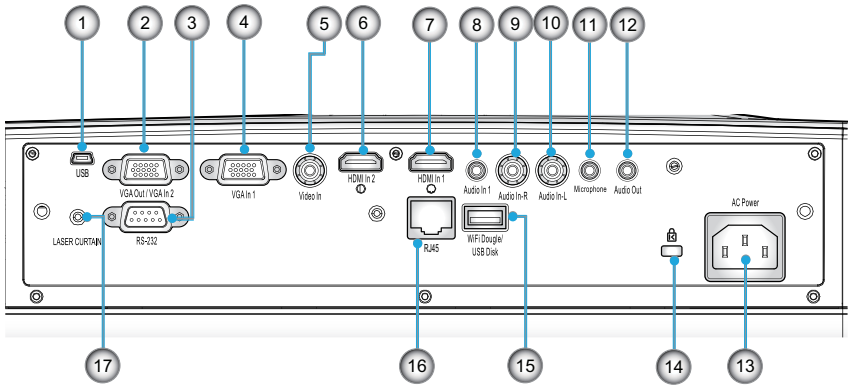

1. USB Connector (For interactivity)
2. VGA-Out/VGA2-In Connector
3. RS-232 Connector (9-pin DIN Type)
4. VGA1-In/YPbPr Connector (PC Analog Signal/Component Video Input/HDTV/YPbPr)
5. Composite Video Input Connector
6. HDMI2 Input Connector
7. HDMI1 Input Connector
8. Audio Input Connector (3.5mm mini jack)
9. Composite Audio Input (right) Connector
10. Composite Audio Input (left) Connector
11. Audio Input Connector (microphone connector)
12. Audio Output Connector (3.5mm mini Jack)
13. Power Socket
14. Kensington™ Lock Port
15. USB Type A Connector
16. RJ45 Connector
17. Laser Curtain



- ❖ Monitor loop through only support in VGA1-In/YPbPr.

# Remote Control



❖ The specific interfaces are selected in terms of the specifications of types.

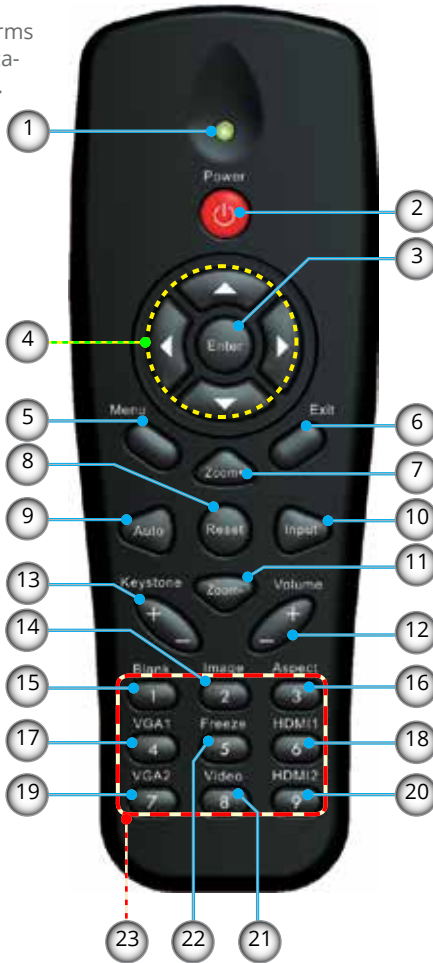

1. LED Indicator
2. Power On/Off
3. Enter
4. Four Directional Key
5. Menu
6. Exit
7. Zoom +
8. Reset
9. Auto Adjustment
10. Input
11. Zoom -
12. Volume +/-
13. Keystone +/-
14. Image
15. Blank
16. Aspect ratio
17. VGA1
18. HDMI1
19. VGA2
20. HDMI2
21. Video
22. Freeze
23. Numbered keypad  
(for password input)

## Connecting the Projector

### Connect a Desktop/Laptop Computer



❖ Remote keys vary with projector types.



❖ Due to application discrepancies in different countries/regions, certain regions may include different accessories

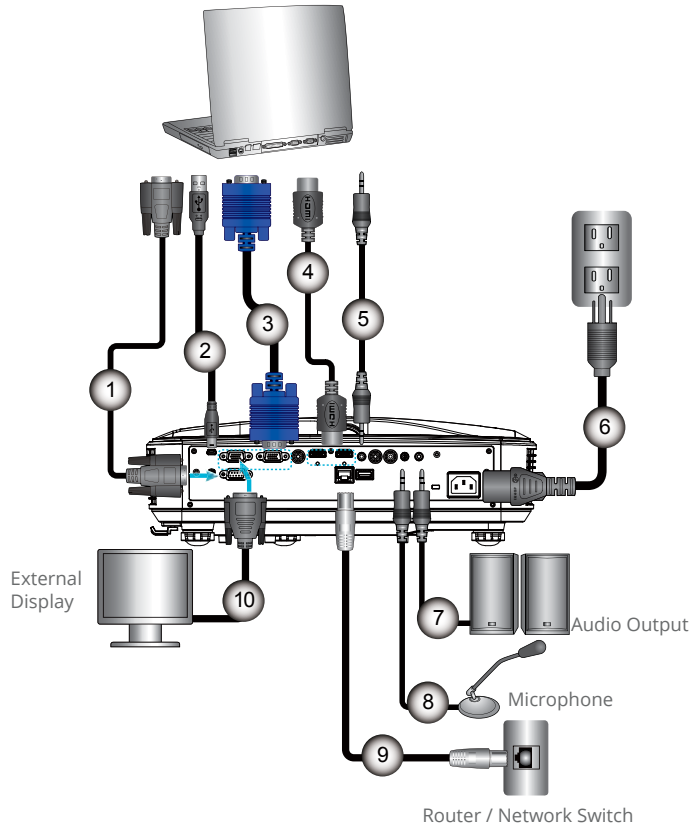

1	.....	RS232 Cable
2	.....	USB Cable
3	.....	VGA Cable
4	.....	HDMI Cable
5	.....	Audio Input Cable
6	.....	Power Cable
7	.....	Audio Output Cable
8	.....	Audio Input Cable
9	.....	RJ45 Cable
10	.....	VGA Output Cable

# Connect to Video Sources



❖ Remote keys vary with projector types.



❖ Due to application discrepancies in different countries/regions, certain regions may include different accessories

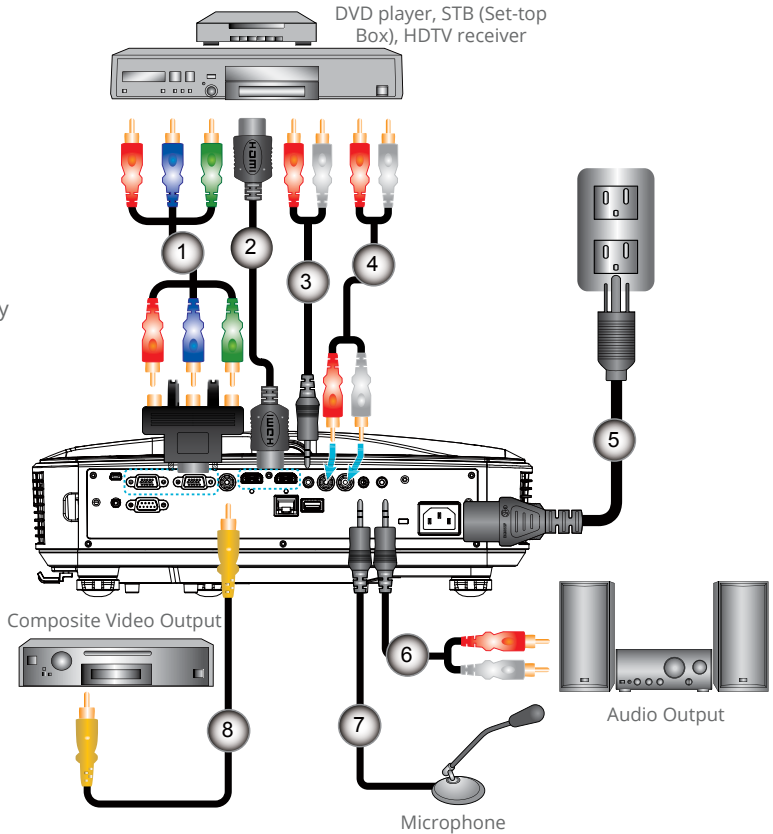

- 1 ..... 15-Pin to 3 RCA Component/HDTV Adapter
- 2 ..... HDMI Cable
- 3 ..... Audio Cable/RCA
- 4 ..... Audio Cable
- 5 ..... Power Cable
- 6 ..... Composite Video Cable
- 7 ..... Audio Cable/RCA
- 8 ..... Audio Input Cable

# Installation

## Powering the Projector On / Off

### Powering On the Projector

1. Securely connect the power cord and signal cable. When connected, the POWER/STANDBY LED will turn Red.
  2. Turn on the lamp by pressing “” button either on the projector or on the remote. At this moment, the POWER/STANDBY LED will now turn Blue. ❶
  3. Turn on and connect the source that you want to display on the screen (computer, notebook, video player, etc). The projector will detect the source automatically. If not, press menu button and go to “OPTIONS”, make sure “Auto Source” is enabled.
- ❖ If you connect multiple sources at the same time, press the “INPUT” button on the control panel or direct source keys on the remote control to switch between inputs.



❖ When the projector is in standby mode (<math><0.5W</math>), the VGA output and the transmitted audio will be deactivated.



❖ Turn on the projector first and then select the signal sources.

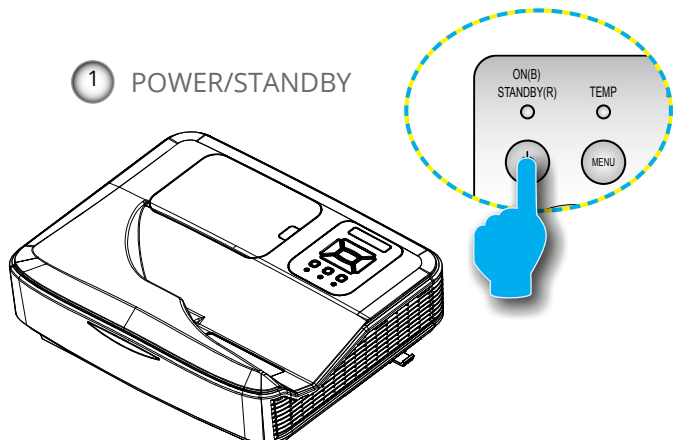

## Powering Off the Projector

1. Press the “⏻” button on the remote control or on the control panel to turn off the projector. The following message will be displayed on the screen.

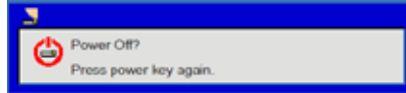

Press the “⏻” button again to confirm otherwise the message will disappear after 15 seconds. When you press the “⏻” button for the second time, the fan will start cooling the system and will shut down.

2. The cooling fans continue to operate for about 35 seconds for cooling cycle and the POWER/STANDBY LED will Flash Blue. When the POWER/STANDBY LED lights solid Red, the projector has entered standby mode.

If you wish to turn the projector back on, you must wait until the projector has completed the cooling cycle and has entered standby mode. Once in standby mode, simply press “⏻” button to restart the projector.

3. Disconnect the power cord from the electrical outlet and the projector.
4. Do not turn on the projector immediately following a power off procedure.

## Warning Indicator

When the warning indicators (see below) come on, the projector will automatically shutdown:

- ❖ “LAMP” LED indicator lights in solid Red.
- ❖ “TEMP” LED flash light in Red, this indicates the projector has overheated. Under normal conditions, the projector can be switched back on.

Unplug the power cord from the projector, wait for 30 seconds and try again. If the warning indicator light up again, please contact your nearest service center for assistance.



- ❖ Contact the nearest service center if the projector displays these symptoms.

## Adjusting the Projected Image

### Adjusting the Projector's Height

*The projector is equipped with Adjustable feet for adjusting the image height.*

1. Locate the adjustable feet you wish to modify on the underside of the projector.
2. Rotate the adjustable ring clockwise to raise the projector or counter clockwise to lower it. Repeat with the remaining feet as needed.

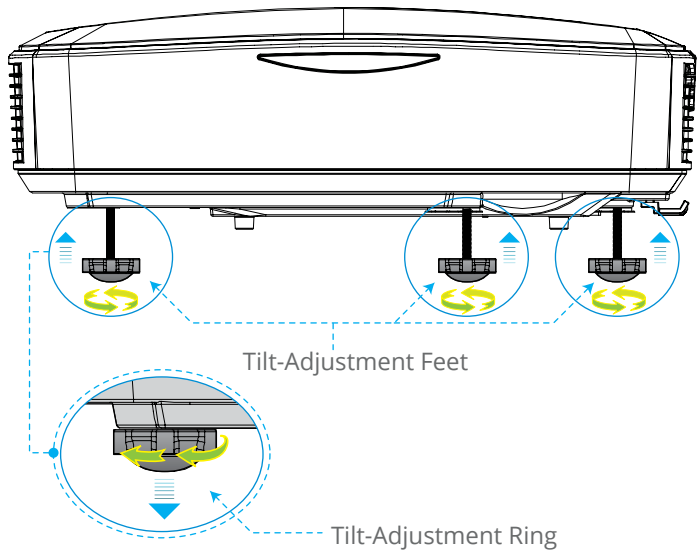

## Adjusting the Projector's Focus

To focus the image, slide the focus lever to left/right until the image is clear.

- ▶ WXGA series: The projector will focus at distances from 1.499 to 2.06 ft. (0.457 to 0.628 meter).

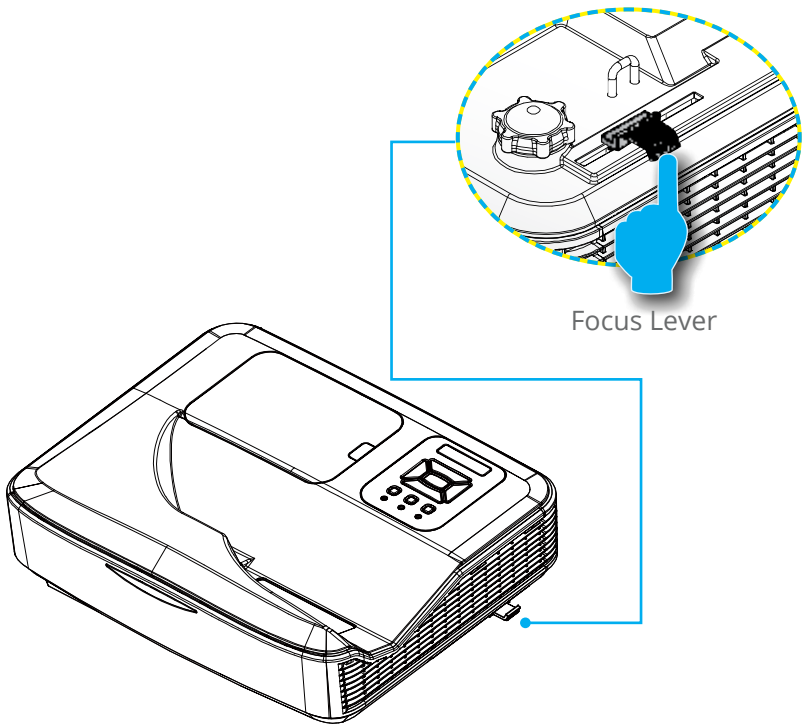



# Installation

## Adjusting Projection Image Size (Diagonal)

- ▶ WXGA series: Projection Image Size from 80" to 110" (2.032 to 2.794 meters).

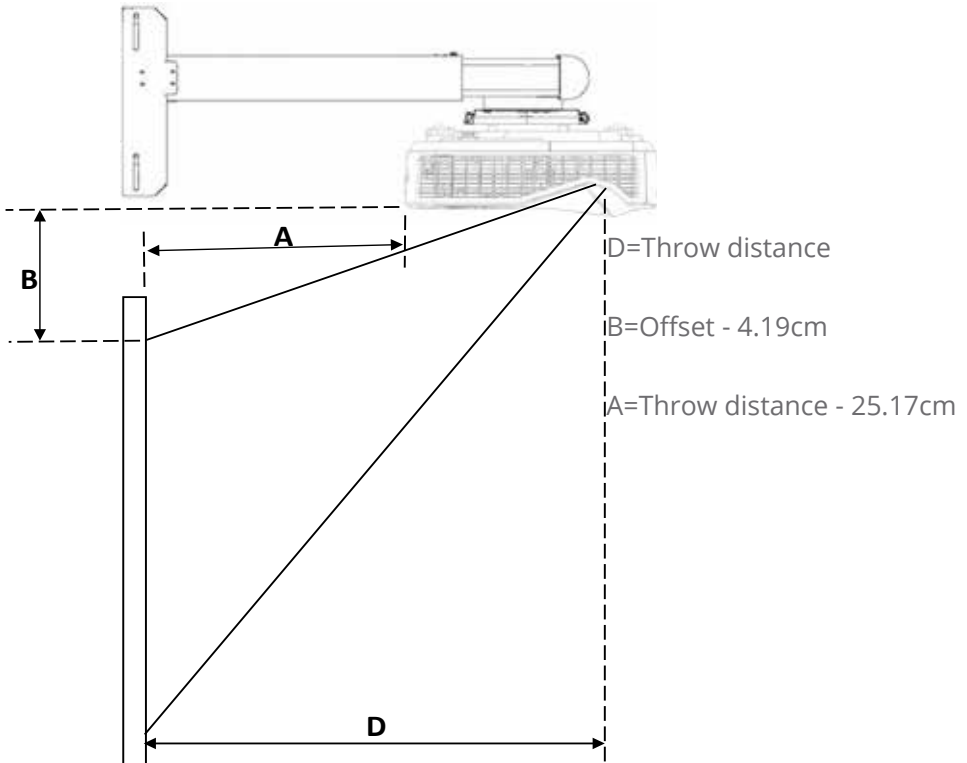

Diagonal of Screen	Screen Size		Projection Distance (D)	Projection Distance (A)	V-Offset (B)
	cm				
	W (Width)	H (Height)	cm	cm	cm
80	172.3	107.7	45.7	21.0	14.26
81	174.5	109	46.2	21.6	14.49
82	176.6	110.4	46.8	22.1	14.74
83	178.8	111.7	47.4	22.7	14.97
84	180.9	113.1	47.9	23.3	15.22
85	183.1	114.4	48.5	23.9	15.45
86	185.2	115.8	49.1	24.4	15.70

Diagonal of Screen	Screen Size		Projection Distance (D)	Projection Distance (A)	V-Offset (B)
	cm				
	W (Width)	H (Height)	cm	cm	cm
87	187.4	117.1	49.7	25.0	15.93
88	189.5	118.5	50.2	25.5	16.17
89	191.7	119.8	50.8	26.1	16.40
90	193.9	121.2	51.4	26.7	16.65
91	196	122.5	51.9	27.3	16.88
92	198.2	123.9	52.5	27.9	17.13
93	200.3	125.2	53.1	28.4	17.36
94	202.5	126.5	53.7	29.0	17.59
95	204.6	127.9	54.2	29.5	17.84
96	206.8	129.2	54.8	30.1	18.07
97	208.9	130.6	55.4	30.7	18.32
98	211.1	131.9	55.9	31.3	18.55
99	213.2	133.3	56.5	31.8	18.79
100	215.4	134.6	57.1	32.4	19.02
101	217.5	136	57.6	33.0	19.27
102	219.7	137.3	58.2	33.6	19.50
103	221.9	138.7	58.8	34.1	19.75
104	224	140	59.4	34.7	19.98
105	226.2	141.4	59.9	35.3	20.23
106	228.3	142.7	60.5	35.8	20.46
107	230.5	144	61.1	36.4	20.69
108	232.6	145.4	61.6	37.0	20.94
109	234.8	146.7	62.2	37.6	21.17
110	236.9	148.1	62.8	38.1	21.41



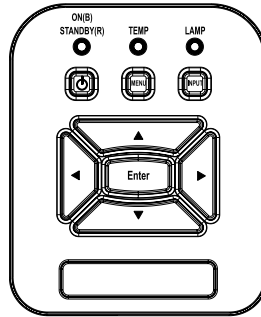

# User controls

## Control Panel & Remote Control

### Control Panel







#### Using the Control Panel

POWER		Press "Power" to turn ON/OFF the projector.
Enter		Press "Enter" to confirm your selected item.
INPUT		Press "INPUT" to select signal source.
MENU		Press "MENU" to launch the on-screen display (OSD) menu. To exit OSD, press "MENU" again.
Four Directional Select Keys		Press     to select item.
LAMP LED		This indicates the lamp status of the projector.
TEMP LED		This indicates the lamp status of the projector.
ON/STANDBY LED		This indicates the status of the projector.

## Remote Control



Using the Remote Control	
LED	LED Indicator.
Power 	Press Power to turn ON/OFF the projector.
Exit	Press "Exit" to close the OSD menu.
Zoom +	Zoom in the display of the projector
Reset	Reset the adjustments to default setting.
Zoom -	Zoom out the display of the projector.
Enter	Confirm your selected item.
Input	Press "Source" to select an input signal.
Auto	Automatically synchronizes the projector to the input source.
Four Directional Select Keys	Use     to select items or make adjustments to your selection.
Keystone +/-	Correct image keystone caused by tilting the projector.
Volume +/-	Adjust the Volume.
Aspect	Use this function to choose your desired aspect ratio.
Menu	Press "Menu" to launch the on-screen display (OSD) menu. To exit OSD, press "Menu" again.
VGA1	Press "VGA1" to choose VGA IN 1 connector.

# User controls



## Using the Remote Control

Blank screen	Momentarily turns off/on the audio and video.
HDMI1	Press "HDMI1" to choose HDMI IN 1 connector.
HDMI2	Press "HDMI2" to choose HDMI IN 2 connector.
VGA2	Press "VGA2" to choose VGA IN 2 connector.
Video	Press "Video" to choose Composite video source.
Freeze screen	Pause the screen image. Press again to resume the screen image.
Image	Select the color mode from Bright, PC, Movie, Game and User.

# On-screen Display Menus

The Projector has multilingual On-screen Display menus that allow you to make image adjustments and change a variety of settings.

## How to operate

1. To open the OSD menu, press "Menu" on the Remote Control or Projector Keypad.
2. When OSD is displayed, use the ▲▼ keys to select any item in the main menu. While making a selection on a particular page, press the ► or "Enter" key to enter sub menu.
3. Use the ▲▼ keys to select the desired item and adjust the settings using the ◀► key.
4. Select the next item to be adjusted in the sub menu and adjust as described above.
5. Press "Enter" to confirm, and the screen will return to the main menu.
6. To exit, press "Menu" again. The OSD menu will close and the projector will automatically save the new settings.

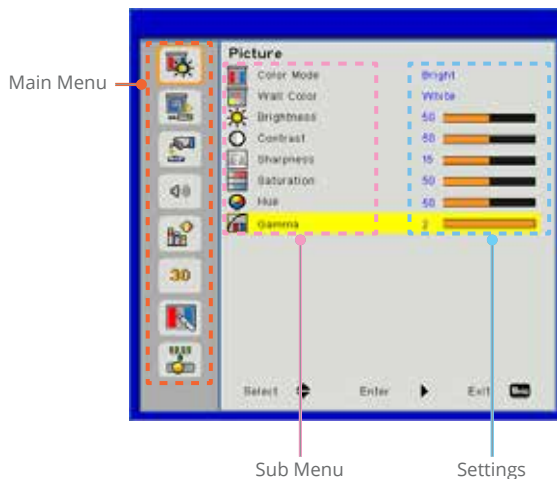

## Picture



### Color Mode

There are many factory presets optimized for various types of images. Use the ◀ or ▶ button to select the item.

- ▶ Bright: For brightness optimization.
- ▶ PC: For meeting presentation.
- ▶ Movie: For playing video content.
- ▶ Game: For game content.
- ▶ User: Memorize user's settings.

### Wall Color

Use this function to obtain an optimized screen image according to the wall color. You can select from "White", "Light Yellow", "Light Blue", "Pink", and "Dark Green".

### Brightness

Adjust the brightness of the image.

- ▶ Press the ◀ button to darken image.
- ▶ Press the ▶ button to darken image.

### Contrast

The Contrast controls the difference between the lightest and darkest parts of the picture. Adjusting the contrast changes the amount of black and white in the image.

- ▶ Press the ◀ button to decrease the contrast.
- ▶ Press the ▶ button to increase the contrast.



- ❖ “Sharpness”, “Saturation” and “Hue” functions are only supported under video mode.

---

## Sharpness

Adjust the sharpness of the image.

- ▶ Press the ◀ button to decrease the sharpness.
- ▶ Press the ▶ button to increase the sharpness.

---

## Saturation

Adjust a video image from black and white to fully saturated color.

- ▶ Press the ◀ button to decrease the amount of saturation in the image.
- ▶ Press the ▶ button to increase the amount of saturation in the image.

---

## Hue

Adjust the color balance of red and green.

- ▶ Press the ◀ button to increase the amount of green in the image.
- ▶ Press the ▶ button to increase the amount of red in the image.

---

## Gamma

This allows you to adjust the gamma value to obtain the better image contrast for the input.



## Screen



### Aspect Ratio

- ▶ Auto: Keep the image with original width-height ratio and maximize the image to fit native horizontal or vertical pixels.
- ▶ 4:3: The image will be scaled to fit the screen and displayed using a 4:3 ratio.
- ▶ 16:9: The image will be scaled to fit the width of the screen and the height adjusted to display the image using a 16:9 ratio.
- ▶ 16:10: The image will be scaled to fit the width of the screen and the height adjusted to display the image using a 16:10 ratio. (only for SSI 1080p).
- ▶ UWHD: The image will be scaled to fit the width of the screen and the height adjusted to display the image using a 16:6 ratio (only for Ultrawide).



- ❖ “H. Position” and “V. Position” ranges will depend on input source.

### Phase

Synchronize the signal timing of the display with the graphic card. If the image appears to be unstable or flickers, use this function to correct it.

### Clock

Adjust to achieve an optimal image when there is a vertical flicker in the image.

### H. Position

- ▶ Press the ◀ button to move the image left.
- ▶ Press the ▶ button to move the image right.

## V. Position

- ▶ Press the ◀ button to move the image down.
- ▶ Press the ▶ button to move the image up.

## Digital Zoom

- ▶ Press the ◀ button to reduce the size of an image.
- ▶ Press the ▶ button to magnify an image on the projection screen.

## V Keystone

Press the ◀ or ▶ button to adjust image distortion vertically. If the image looks trapezoidal, this option can help make the image rectangular.

## Ceiling Mount

- ▶ Front: The image is projected straight on the screen.
- ▶ Front Ceiling: This is the default selection. When selected, the image will turn upside down.
- ▶ Rear: When selected, the image will appear reversed.
- ▶ Rear Ceiling: When selected, the image will appear reversed in upside down position.

# User controls

## Setting



### Language

Choose the multilingual OSD menu. Press the ◀ or ▶ button into the sub menu and then use the ▲ or ▼ button to select your preferred language. Press ▶ on the remote control to finalize the selection.



### Menu Location

Choose the menu location on the display screen.

### Closed Caption

Use this function to enable close caption menu. Select an appropriate closed captions option: Off, CC1, CC2, CC3, and CC4.

### VGA Output (Standby)

Choose "On" to enable VGA OUT connection.

### LAN (Standby)

Choose "On" to enable LAN connection. Choose "Off" to disable LAN connection.

### VGA B (Function)

- ▶ Input: Choose "Input" to let the VGA port works as a VGA input function.
- ▶ Output: Choose "Output" to enable the VGA Out function once the projector is powered on.

### Test Pattern

Display a test pattern.

### Reset

Choose "Yes" to return the parameters on all menus to the factory default settings.

## Volume



### Speaker

- ▶ Choose "On" to enable the speaker.
- ▶ Choose "Off" to disable the speaker.

### Line Out

- ▶ Choose "On" to enable the line out function.
- ▶ Choose "Off" to disable the line out function.

### Microphone

- ▶ Choose "On" to enable the microphone.
- ▶ Choose "Off" to disable the microphone.

### Mute

- ▶ Choose "On" to turn mute on.
- ▶ Choose "Off" to turn mute off.

### Volume

- ▶ Press the ◀ button to decrease the volume.
- ▶ Press the ▶ button to increase the volume.

### Microphone Volume

- ▶ Press the ◀ button to decrease the microphone volume.
- ▶ Press the ▶ button to increase the microphone volume.

# Options



## Logo

Use this function to set the desired startup screen. If changes are made they will take effect the next time the projector is powered on.

- ▶ Default: The default startup screen.
- ▶ User: Use stored picture from “Logo Capture” function.



- ❖ For successful logo capture, please ensure that the on-screen image does not exceed the projector’s native resolution. (WXGA:1280x800).
- ❖ “Logo Capture” is not available when 3D is enabled.
- ❖ Before active this function, it is recommended that “Aspect Ratio” is set to the “Auto”.

## Logo Capture

Press ▶ button to capture an image of the picture currently displayed on screen.

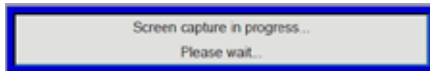

## Auto Source

- ▶ On: The projector will search for other signals if the current input signal is lost.
- ▶ Off: The projector will only search current input connection.

## Input

Press ▶ button to enable/disable input sources. The projector will not search for inputs that are not selected.



## Auto Power Off (Min)

Sets the countdown timer interval. The countdown timer will start, when there is no signal being sent to the projector. The projector will automatically power off when the countdown has finished (in minutes).



- ❖ “Dynamic Black” is available when “Color Mode” is set to “Movie”.
- ❖ “Dynamic Black” is not available when “3D” or “Interactive” is enabled.
- ❖ When “Dynamic Black” is available, “Lamp Power Mode” selection is not available.

## Lamp Settings

Refer to page 32.

## High Altitude

- ▶ On: The built-in fans run at high speed. Select this option when using the projector at altitudes above 2500 feet/762 meters or higher.
- ▶ Off: The built-in fans automatically run at a variable speed according to the internal temperature.

## Filters Remind (Hour)

- ▶ Filters Remind (Hour): Set the filter reminder time.
- ▶ Cleaning Up Remind: Select “Yes” to reset the dust filter hour counter after replacing or cleaning the dust filter.

## Information

Display the projector information for model name, SNID, source, resolution, software version, and aspect ratio on the screen.

# Options | Lamp Settings

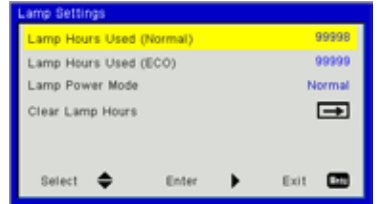

## Lamp Hours Used (Normal)

Display the projection time of normal mode.

## Lamp Hours Used (ECO)

Display the projection time of ECO mode.

## Lamp Power Mode

- ▶ Normal: Normal mode.
- ▶ ECO: Use this function to dim the projector lamp which will lower power consumption and extend the lamp life.

## Clear Lamp Hours

Choose "Yes" to reset the lamp hour counter after replacing the lamp.



## 3D



- ❖ “Frame Sequential” is supported the DLP Link 3D input signals from VGA / HDMI connector.
- ❖ “Frame Sequential” / “Field Sequential” are supported the HQFS 3D input signals from Composite/S-Video connector.
- ❖ “Frame Packing” / “Side-by-Side(Half)” / “Top and Bottom” are supported from HDMI 1.4a 3D input signals.

### 3D

- ▶ Auto: When a HDMI 1.4a 3D timing identification signal is detected, the 3D image is selected automatically.
- ▶ Choose “On” to enable 3D function.
- ▶ Choose “Off” to disable 3D function.

### 3D Invert

If you see a discrete or overlapping image while wearing DLP 3D glasses, you may need to execute “Invert” to get best match of left/right image sequence to get the correct image.

### 3D Format

Use this feature to select the 3D format. Options are: “Frame Packing”, “Side-by-Side (Half)”, “Top and Bottom”, “Frame Sequential”, and “Field Sequential”.

### 1080p@24

Use this feature to select 96 or 144Hz refresh rate as using 3D glasses in the 1080p @ 24 frame packing.

# Interactive



- ❖ The Interactive function is available when displaying graphic source from HDMI/VGA input. Other sources are not supported.
- ❖ If "3D" or "Dynamic Black" function is enabling, "Interactive" feature is disabling.
- ❖ Interaction function: Please specify that the Interaction function is only for USTi model. The Interaction function is not available in the UST model.

## Interactive Settings

- ▶ Choose "On" to enable Interactive function.
- ▶ Choose "Off" to disable Interactive function.

You need to unplug the Mini USB cable that connects NB/desktop with the projector before using the Interactive function. After you complete the Interactive Settings in OSD, use Mini USB cable to connect NB/desktop with the projector.

# User controls

## LAN



### Status

Display the network connection status.

### DHCP

Configure the DHCP settings.

- ▶ On: Choose "On" to let the projector to obtain an IP address automatically from your network.
- ▶ Off: Choose "Off" to assign IP, Subnet Mask, Gateway, and DNS configuration manually.

### IP Address

Display an IP address.

### Subnet Mask

Display the subnet mask number.

### Gateway

Display the default gateway of the network connected to the projector.

### DNS

Display the DNS number.

### MAC Address

Display the MAC address.

### Group Name

Display the group name.

### Projector Name

Display the projector name.

### Location

Display the projector location.

### Contact

Display the contact information.

# User controls

## How to use web browser to control your projector

1. Turn on DHCP to allow a DHCP server to automatically assign an IP, or manually enter the required network information.

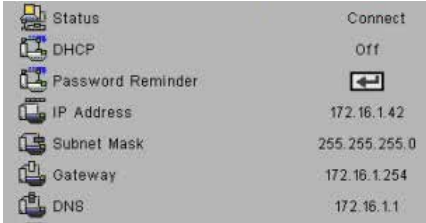

2. Then choose apply and press **OK** button to complete the configuration process.
3. Open your web browser and type in IP Address from the OSD LAN screen then the web page will display as below:



- ❖ When you used the projector IP address, you will can not link to your service server.

4. Based on network web-page for the input-string in [tools] tab, the limitation for Input-Length is in the below list ("space" and the other punctuation key included):

Category	Item	Input-Length (characters)
Crestron Control	IP Address	15
	IP ID	2
	Port	5
Projector	Projector Name	10
	Location	9
	Assigned To	9
Network Configuration	DHCP (Enabled)	(N/A)
	IP Address	15
	Subnet Mask	15
	Default Gateway	15
	DNS Server	15
User Password	Enabled	(N/A)
	New Password	15
	Confirm	15
Admin Password	Enabled	(N/A)
	New Password	15
	Confirm	15



## When making a direct connection from your computer to the projector

Step 1: Find an IP Address (192.168.0.100) from LAN function of projector.



Step 2: Select apply and press “Enter” button to submit function or press “menu” key to exit.

Step 3: To open Network Connections, click **Start**, click **Control Panel**, click **Network and Internet Connections**, and then click **Network Connections**. Click the connection you want to configure, and then, under **Network Tasks** , click **Change settings of this connection**.

Step 4: On the **General** tab, under **This connection uses the following items**, click **Internet Protocol (TCP/IP)**, and then click “Properties.”

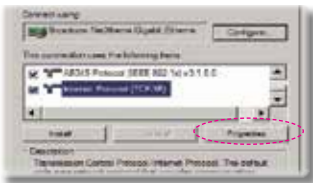

Step 5: Click **Use the following IP address**, and type in as below:

1) IP address: 192.168.0.100

2) Subnet mask: 255.255.255.0

3) Default gateway:192.168.0.254

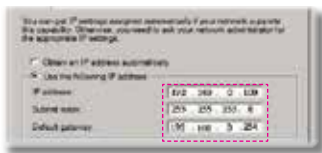

Step 6: To open Internet Options, click IE web browser, click Internet Options, click the **Connections** tab and click “LAN Settings...”.

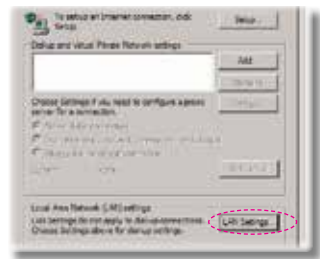

Step 7: The **Local Area Network (LAN) Setting** dialog box appears. In the **Proxy Server** area, cancel the **Use a proxy server for your LAN** check box, then click “OK” button twice.

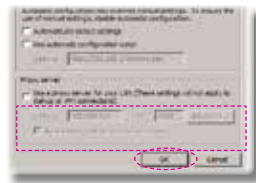

Step 8: Open your IE and type in the IP address of 192.168.0.100 in the URL then press “Enter” key.

# User controls

## Crestron RoomView Control Tool

Crestron RoomView™ provides a central monitoring station for 250+ control systems on a single Ethernet network (more are possible, the number depends on the combination of IP ID and IP address). Crestron RoomView monitors each projector, including projector's online status, system power, lamp life, network setting and hardware faults, plus any custom attribute as defined by the Administrator. The Administrator can add, delete, or edit room information, contact information and events, which are logged automatically by the software for all users. (Operation UI as following image)

### 1. Main Screen

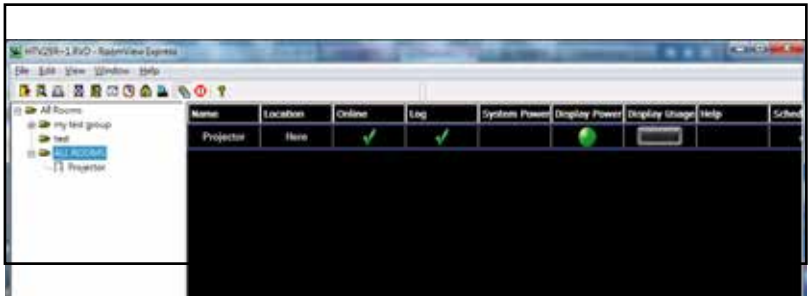

### 2. Edit Room

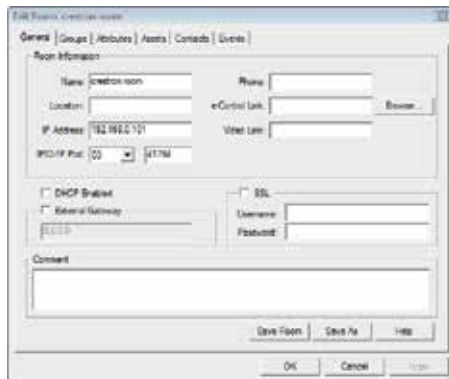

### 3. Edit Attribute



### 4. Edit Event



***For further information, please visit:  
<http://www.crestron.com> & [www.crestron.com/getroomview](http://www.crestron.com/getroomview).***



## Accessing Multimedia Files

This projector supports two methods to project the media files (photos, videos, music, documents) stored on following devices:

- a. via Wireless dongle (optional) - wirelessly access the media files stored on your mobile phone, tablet PC, notebook, or desktop.
- b. via USB flash drive - directly access the media files stored in the device.

### How to access Multimedia mode

1. Plug a wireless dongle or a USB flash drive into the USB connector at the back of projector.

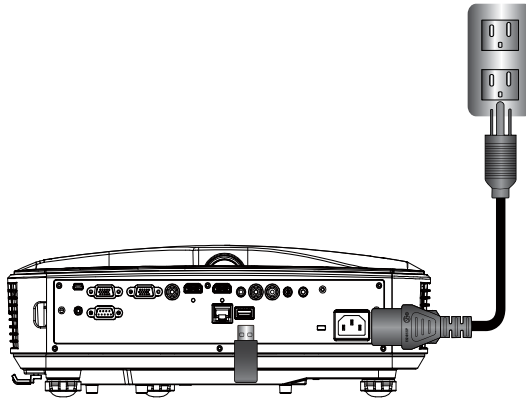

2. Press "INPUT" on the remote control or on the control panel to turn on the projector. When the Input menu appears, press the ▲ ▼ keys to select "Multimedia" and the "Enter" key to confirm.

## Mobile Display

To access the media files stored on your mobile device or tablet PC, do the following:

1. On **Multimedia** menu, select **Mobile/Tablet**.



2. On your mobile device or tablet PC, download "EZview" application App Store (iOS) or Play Store (Android).



3. Enable your mobile device or tablet PC WiFi function, and search the AP name listed in the Wi-Fi network list.
4. On the initial connection, you will be prompted to enter a password. Enter the password.
5. Launch "EZview" application and enter the PCTOOL password.
6. Wait until the connection is established. The media files on your mobile device or tablet PC can be accessed using the projector.

## Laptop Display

To access the media files stored on your laptop/notebook, do the following:

1. On **Multimedia** menu, select **Laptop**.

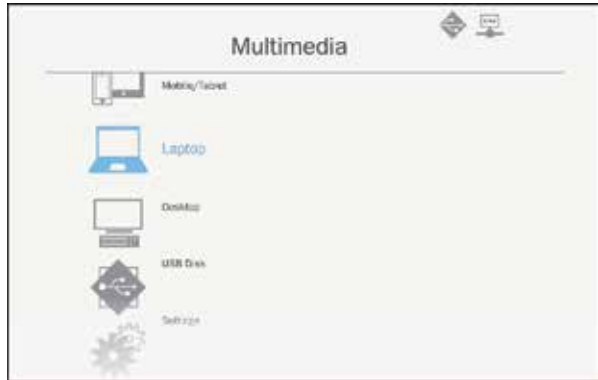

2. Enable your laptop/notebook WiFi function, and search the AP name listed in the Wi-Fi network list.



3. On the initial connection, you will be prompted to enter a password. Enter the password.
4. Open your web browser and enter the IP address. Then select "Wifi" on the left side of the screen and install application required by the operation system.
5. Launch "EZview" application and enter the control code shown on the right-bottom side of the screen.

6. Wait until the connection is established. The media files on your laptop/notebook can be accessed using the projector.

## Desktop Display

To access the media files stored on your desktop, do the following:

1. On **Multimedia** menu, select **Desktop**.

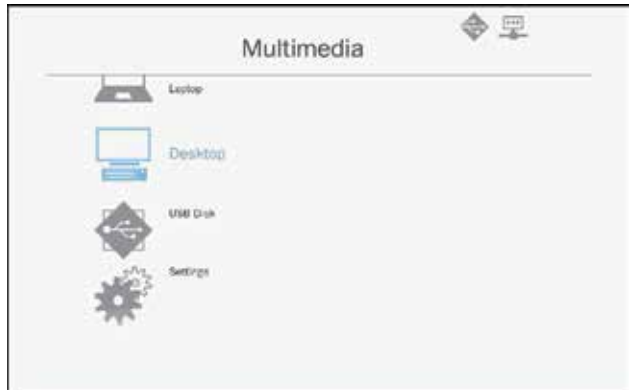

2. Open your web browser and enter the IP address. Then select "Wifi" on the left side of the screen and install application required by the operation system.



# Multimedia

3. Launch “EZview” application and enter the control code shown on the right-bottom side of the screen.
4. Wait until the connection is established. The media files on your desktop can be accessed using the projector.

## USB Storage Display

To access the media files stored on your USB flash drive, do the following:

### Supported File Format

Multimedia Category	File Format
Photo	BMP, JPG, PNG
Music	MP3, WMA
Video	AVI, MOV, MP4, RM, RMVB, DAT, MPG, ISO, TS, MKV, VOB, and WMV
Document	WORD, EXCEL, PPT, PDF

1. On **Multimedia** menu, select **USB Disk**.

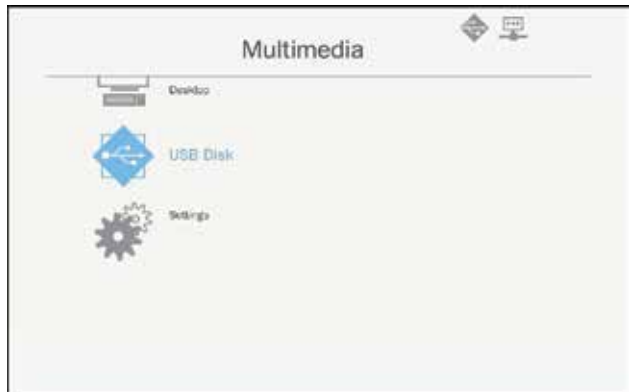

2. Use the ▲▼ keys to select the file category and press the “Enter” key.

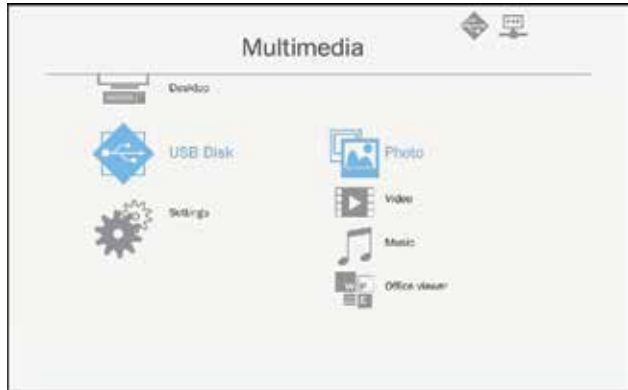

3. Use the ▲▼ keys to select the file to view/play and press the “Enter” key to confirm.

### Configuring Multimedia Settings

To change the settings, do the following:

1. On **Multimedia** menu, select **Settings**.

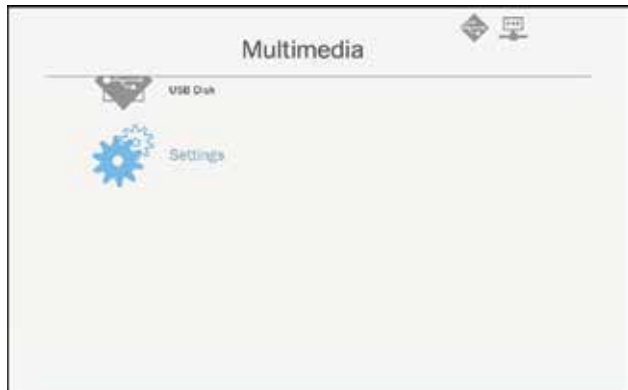

# Multimedia

2. Use the ▲▼ keys to select the desired menu option and press the “Enter” key to enter the submenu.



- ▶ System: Select this option to view the firmware version and update firmware.
  - ▶ Video: Select this option to change the display ratio and set the repeat mode.
  - ▶ Photo: Select this option to change the display ratio, slideshow pattern, and slideshow duration.
  - ▶ Music: Select this option to set the repeat mode.
  - ▶ WiFi: Select this option to configure the Wi-Fi connection.
3. Use the ▲▼ keys to select the adjust/select the setting and press the “Enter” key to confirm.

# Replace the Lamp

This projector will automatically detect the service life of its lamp. When service life of the lamp is about to expired, a warning message will be displayed.

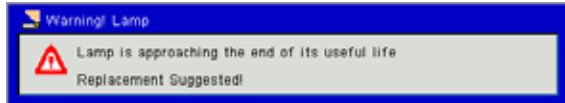

When you see this message, please contact the local dealer or service center to replace the lamp as soon as possible. Please be sure that the projector has been cooled down for at least 30 minutes before replacement of the lamp.

 CAUTION! 小心!

CAUTION:  
HIGH-PRESSURE LAMP MAY EXPLODE IF IMPROPERLY HANDLED.  
REFER TO LAMP REPLACEMENT INSTRUCTIONS

ATTENTION: Les lampes à haute pression peuvent exploser si elles sont mal utilisées. Confier l'entretien à une personne qualifiée

注意：  
如果处理不当，高压灯泡可能会爆炸，请参阅更换灯泡的说明

LAMPS CONTAIN MERCURY AND MUST BE RECYCLED OR DISPOSED OF  
ACCORDING TO LOCAL, STATE, OR FEDERAL LAWS.  
 灯泡内含汞，必须根据当地、州或联邦法律进行回收或处理。

 Warning: If the projector is installed on the ceiling, please handle carefully when you open the lamp cover. If the projector is installed on the ceiling, we suggest that you wear safety glasses when replacing the lamp. "Always handle carefully to prevent any loose component from falling off the projector."

 Warning: The lamp Component may be hot! Replace the lamp after it is cooled down!

 Warning: To reduce the risk of personal injury, please prevent the lamp module from falling down and avoid touching the lamp. If the lamp falls down, it may be broken up, which may cause injury.



- ❖ The screws on the lantern and the lamp shall not be removed.
- ❖ If the lamp cover is not reinstalled on the projector yet, the projector cannot be switched on.
- ❖ Do not touch the glass area of the lamp. Oil on hands may cause the lamp to break up. If you accidentally touch the lamp module, please clean it with dry cloth.

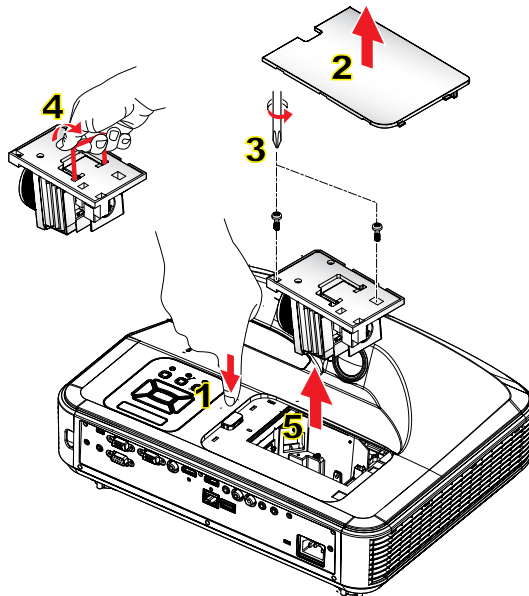

## ○ Cleaning procedure for air filter: ○

1. Press “**⏻**” button to power off the projector.
2. Cool down the projector for at least 30 minutes.
3. Pull off the power cable.
4. Press the release button, and pull up the lamp cover of the main components. **1**
5. Lift up and remove the lamp cover. **2**
6. Remove the 2 screws on the lamp module. **3**
7. Pull up the Lamp Handle **4**, and pull out the lamp module carefully and slowly. **5**

Follow the aforesaid steps in the reverse order to install the lamp module.

8. After the lamp module is replaced, switch on the projector and reset the lamp hour counter.

To reset the lamp, please finish the following steps:

- (i) Press **▼→▲→▲→◀→▲** to open the “**Service**” menu.
- (ii) Select “**Reset Lamp Hours**”.
- (iii) Press “**OK**” to confirm the selection.

# Installing and Cleaning the Optional Dust Filter

We recommend that you clean the dust filter according to the level of dust in the environment.

Make sure the dust filter is never obstructed by retaining dust, and always allow enough air to flow through easily.



- ❖ The optional dust filter should be used in dusty environments.
- ❖ If the dust filter is installed, a proper maintenance will prevent overheating and projector malfunction.

The usage time of the dust filter is reached.  
Please clean the dust filters for better performance.

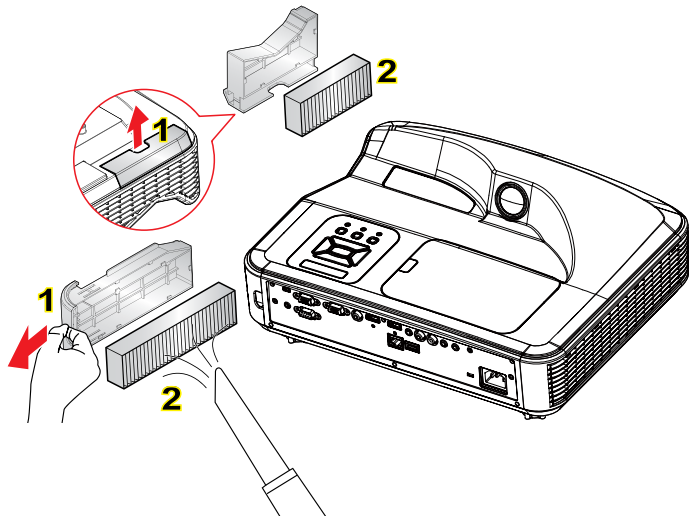

## ○ Air Filter Cleaning Procedure: ○

1. Turn off the projector.
2. Disconnect the power cord.
3. Pull out the lock, and remove the Component of the dust filter, as shown in the illustration. **1**
4. Carefully remove the air filter. Then using vacuum to clean or change the filter directly. Follow the aforesaid steps in the reverse order to install the filter. **2**

To install the filter, please return to the previous step.

5. Turn on the projector and reset the filter usage counter after the dust filter is replaced.

## Compatibility Modes

### ▸ VGA Analog

a. PC Signal			
Modes	Resolution	V.Frequency [Hz]	H.Frequency [KHz]
VGA	640x480	60	31.5
	640x480	67	35
	640x480	72	37.9
	640x480	75	37.5
	640x480	85	43.3
IBM	720x400	70	31.5
SVGA	800x600	56	35.1
	800x600	60	37.9
	800x600	72	48.1
	800x600	75	46.9
	800x600	85	53.7
	800x600	120	77.4
Apple, Mac II	832x624	75	49.1
XGA	1024x768	60	48.4
	1024x768	70	56.5
	1024x768	75	60
	1024x768	85	68.7
	1024x768	120	99
Apple, Mac II	1152x870	75	68.7
SXGA	1280x1024	60	64
	1280x1024	72	77
	1280x1024	75	80
QuadVGA	1280x960	60	60
	1280x960	75	75.2
SXGA+	1400x1050	60	65.3
UXGA	1600x1200	60	75

<b>b. Extended Wide timing</b>			
Modes	Resolution	V.Frequency [Hz]	H.Frequency [KHz]
WXGA	1280x720	60	44.8
	1280x720	120	92.9
	1280x800	60	49.6
	1366x768	60	47.7
	1440x900	60	59.9
WSXGA+	1680x1050	60	65.3
<b>c. Component Signal</b>			
Modes	Resolution	V.Frequency [Hz]	H.Frequency [KHz]
480i	720x480 (1440x480)	59.94(29.97)	15.7
576i	720x576 (1440x576)	50(25)	15.6
480p	720x480	59.94	31.5
576p	720x576	50	31.3
720p	1280x720	60	45
720p	1280x720	50	37.5
1080i	1920x1080	60(30)	33.8
1080i	1920x1080	50(25)	28.1
1080p	1920x1080	23.98/24	27
1080p	1920x1080	60	67.5
1080p	1920x1080	50	56.3

## ► HDMI Digital

a. PC Signal			
Modes	Resolution	V.Frequency [Hz]	H.Frequency [KHz]
VGA	640x480	60	31.5
	640x480	67	35
	640x480	72	37.9
	640x480	75	37.5
	640x480	85	43.3
IBM	720x400	70	31.5
SVGA	800x600	56	35.1
	800x600	60	37.9
	800x600	72	48.1
	800x600	75	46.9
	800x600	85	53.7
Apple, Mac II	832x624	75	49.1
XGA	1024x768	60	48.4
	1024x768	70	56.5
	1024x768	75	60
	1024x768	85	68.7
	1024x768	120	99
Apple, Mac II	1152x870	75	68.7
SXGA	1280x1024	60	64
	1280x1024	72	77
	1280x1024	75	80
QuadVGA	1280x960	60	60
	1280x960	75	75.2
SXGA+	1400x1050	60	65.3
UXGA	1600x1200	60	75

<b>b. Extended Wide timing</b>			
Modes	Resolution	V.Frequency [Hz]	H.Frequency [KHz]
WXGA	1280x720	60	44.8
	1280x720	120	92.9
	1280x800	60	49.6
	1366x768	60	47.7
	1440x900	60	59.9
WSXGA+	1680x1050	60	65.3
<b>c. HDMI - Video Signal</b>			
Modes	Resolution	V.Frequency [Hz]	H.Frequency [KHz]
640x480p	640x480	59.94/60	31.5
480i	720x480 (1440x480)	59.94(29.97)	15.7
576i	720x576 (1440x576)	50(25)	15.6
480p	720x480	59.94	31.5
576p	720x576	50	31.3
720p	1280x720	60	45
720p	1280x720	50	37.5
1080i	1920x1080	60(30)	33.8
1080i	1920x1080	50(25)	28.1
1080p	1920x1080	23.98/24	27
1080p	1920x1080	60	67.5
1080p	1920x1080	50	56.3
<b>d. HDMI 1.4a mandatory 3D timing- Video Signal</b>			
Modes	Resolution	V.Frequency [Hz]	H.Frequency [KHz]
Frame Packing	720p	50	
	720p	59.94/60	
	1080p	23.98/24	
Side-by-Side	1080i	50	
	1080i	59.94/60	
Top-and-Bottom	720p	50	
	720p	59.94/60	
	1080p	23.98/24	

## RS232 Commands and Protocol Function List

### ▶ RS232 Port Setting

Items	Method
Communication Method	Asynchronous Communication
Bits per seconds	19200
Data bits	8 bits
Parity	None
Stop bits	1
Flow control	None



- ❖ RS232 shell is grounded.

### ▶ RS232 Signals Connection

Computer COM Port  
(D-Sub 9pin connector)

Projector COM Port  
(D-Sub 9pin connector)

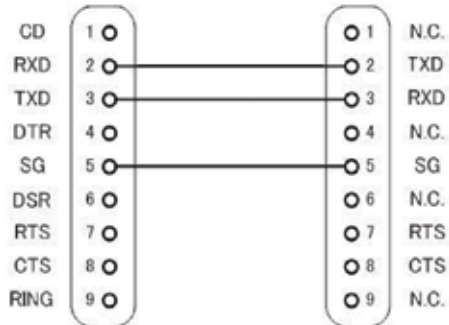

## ► Commands Set List

Command Type	Command Description	ASCII Code					Read / Write	Projector Return	Comment
		Header	Msg ID	Command	Space	Value			
IR / Keypad	Power	#	00	00		0 ~ 1	Write		0 : Off 1 : On
IR / Keypad	Emulate Remote	#	00	01		1 ~ 10	Write		1 : Up 2 : Left 3 : Right 4 : Down 5 : Menu 6 : Source 7 : Keystone+ 8 : Keystone- 9 : Volume+ 10 : Volume-
IR / Keypad	Resync	#	00	02		1	Write		VGA only
IR / Keypad	AV Mute (Blank)	#	00	03		0 ~ 1	Write		0 : Off 1 : On
IR / Keypad	Freeze	#	00	04		0 ~ 1	Write		0 : Unfreeze 1 : Freeze
IR / Keypad	Input Source	#	00	05		1 ~ 6	Write		1 : VGA 1 2 : VGA 2 3 : HDMI 1 4 : HDMI 2 5 : Video 6 : Multimedia
Picture	Color Mode	#	00	10		1 ~ 5	Write		1 : Bright 2 : PC 3 : Movie 4 : Game 5 : User
Picture	Brightness	#	00	11		0 ~ 100	Write		
Picture	Contrast	#	00	12		0 ~ 100	Write		
Picture	Sharpness	#	00	13		0 ~ 31	Write		Video only
Screen	Aspect Ratio	#	00	20		1 ~ 4	Write		1 : Auto 2 : 4:3 3 : 16:9 4 : 16:10 / Ultra Wide
Screen	Zoom	#	00	21		0 ~ 1	Write		0 : Zoom- 1 : Zoom+
Screen	Keystone	#	00	22		-40 ~ 40	Write		



# Apendices

Screen	Ceiling Mount	#	00	23		1 ~ 4	Write		1 : Front 2 : Rear 3 : Front Ceiling 4 : Rear Ceiling
Setting	Language	#	00	30		1 ~ 18	Write		1 : English 2 : German 3 : Swedish 4 : French 5 : Arabic 6 : Dutch 7 : Norwegian 8 : Danish 9 : Simplified Chinese 10 : Polish 11 : Korean 12 : Russian 13 : Spanish 14 : Traditional Chinese 15 : Italian 16 : Portuguese 17 : Turkish 18 : Japanese
Setting	Menu Location	#	00	31		1 ~ 5	Write		1 : Top Left 2 : Top Right 3 : Center 4 : Bottom Left 5 : Bottom Right
Setting	Reset	#	00	32		1	Write		
Volume	Mute	#	00	40		0 ~ 1	Write		0 : Off 1 : On
Volume	Volume	#	00	41		0 ~ 30	Write		
Volume	Microphone Volume	#	00	42		0 ~ 30	Write		
Options	Auto Power Off (min)	#	00	50		0 ~ 120	Write		Step = 5
Options	High Altitude	#	00	51		0 ~ 1	Write		0 : Off 1 : On
Picture	Color Mode Read	#	00	110		1	Read	Okn	n : 1/2/3/4/5 = Bright / PC / Movie / Game / User
Screen	Aspect Ratio Read	#	00	120		1	Read	Okn	n : 1/2/3/4 = Auto / 4:3 / 16:9 / 16:10
Options	Input Source (curr. src)	#	00	160		1	Read	Okn	n : 0/1/2/3/4/5/6 = None / VGA1 / VGA2 / HDMI1 / HDMI2 / Video / Multimedia

Options	Software Version	#	00	161		1	Read	Okddd	ddd : FW version
Options	Information	#	00	162		1	Read	Okabbbb ccdde	a : Power Status / b : LD Hour / c : Input Source / d : Firmware Version / e : Color mode

## List of specifications

Item	Specification
Model	i3PROJECTOR 3303W
Resolution	WXGA
Graphics Card DMD Dimensions	0.65"
Projector Technology	DLP
Projector Lens	Fixed Lens, f/2.4
Lighting Technology	Philips Smart Energy-Saving Lamp
Brightness	Typical: 3500 lumens, Minimum: 3150 lumens
Contrast	Typical 1800:1, Mim 1600:1. (Native) Typical 10000:1 Mim 8000:1. (High Contrast Ratio mode)
Supported resolution	Up to 1080p @ 60Hz (CEA 861)
Throw Ratio	0.27
Weight (KG)	4.5KG
Dimensions	383mm(W) x 310mm(D) x 103mm(H) (excluding foot)
Light Power	260W
Light Life	3000 Hours / 4000 Hours (ECO Mode)
Total Power (W)	320W
Standby Power (W)	<0.5W
Audio Output	10W
Operating Noise	34dB / 29dB (ECO Mode)
Input Terminals	
VGA and Y/Pb/Pr	X1: D-sub female 15 pin terminal (blue)
HDMI	X2: Standard HDMI terminal 1)Support HDMI input with HDMI 1.4a compliant. 2)Supports High bandwidth Digital Content Protection – HDCP Standard 1.3 of December 2006
VGA Audio	X1: Stereo mini jack
MIC	X1: Stereo mini jack
Composite Video	X1: RCA (yellow)
Composite Audio	X2: RCA for both left and right

USB-A	X1: for Pen Drive and provide 5V/0.5A
<b>Output Terminals</b>	
Audio	X1: Stereo mini jack(green)
VGA	X1: D-sub female 15 pin terminal (black) (Support VGA in function)
<b>Other Terminals</b>	
Mini USB-B	Mini USB type B (for FW download)
RS232	DB9 Male terminal
RJ45	RJ45 for LAN control

※Based on ISO21118: the nominal value represents average value of the product during mass production. The minimum factory value of the product is 80% of the nominal value.

## Wall Mount Installation

If you wish to use a third party ceiling mount kit, please ensure the screws used to attach a mount to the projector meet the following specifications:

- ▶ Screw type: M4\*4
- ▶ Minimum screw length: 10mm



❖ Please note that damage resulting from incorrect installation will void the warranty.



 Warning:

1. If you buy a ceiling mount from another company, please be sure to use the correct screw size. Screw size will vary depending on the thickness of the mounting plate.
2. Be sure to keep at least 10 cm gap between the ceiling and the bottom of the projector.
3. Avoid installing the projector near a heat source.

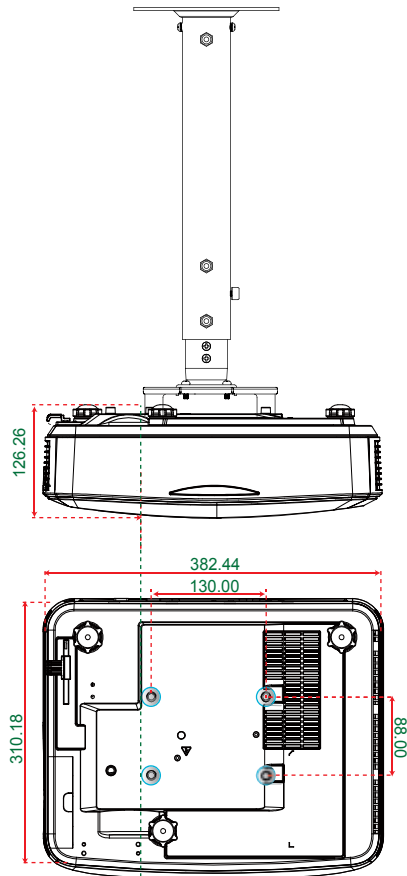

Unit: mm

# Regulation & Safety Notices

*This appendix lists the general notices of your projector.*

## ***FCC notice***

This device has been tested and found to comply with the limits for a Class B digital device pursuant to Part 15 of the FCC rules. These limits are designed to provide reasonable protection against harmful interference in a residential installation. This device generates, uses and can radiate radio frequency energy and, if not installed and used in accordance with the instructions, may cause harmful interference to radio communications.

However, there is no guarantee that interference will not occur in a particular installation. If this device does cause harmful interference to radio or television reception, which can be determined by turning the device off and on, the user is encouraged to try to correct the interference by one or more of the following measures:

- Reorient or relocate the receiving antenna.
- Increase the separation between the device and receiver.
- Connect the device into an outlet on a circuit different from that to which the receiver is connected.
- Consult the dealer or an experienced radio/television technician for help.

## ***Notice: Shielded cables***

All connections to other computing devices must be made using shielded cables to maintain compliance with FCC regulations.

## ***Caution***

Changes or modifications not expressly approved by the manufacturer could void the user's authority, which is granted by the Federal Communications Commission, to operate this projector.

## **Operation conditions**

This device complies with Part 15 of the FCC Rules. Operation is subject to the following two conditions:

1. This device may not cause harmful interference and
2. This device must accept any interference received, including interference that may cause undesired operation.

## **Notice: Canadian users**

This Class B digital apparatus complies with Canadian ICES-003.

## **Remarque à l'intention des utilisateurs canadiens**

Cet appareil numérique de la classe B est conforme à la norme NMB-003 du Canada.

## **Declaration of Conformity for EU countries**

- EMC Directive 2004/108/EC (including amendments)
- Low Voltage Directive 2006/95/EC
- R & TTE Directive 1999/5/EC (if product has RF function)

### **Disposal instructions**



**Do not throw this electronic device into the trash when discarding. To minimize pollution and ensure utmost protection of the global environment, please recycle it.**

AUTHORISED RESELLER



[WWW.I3-TECHNOLOGIES.COM](http://WWW.I3-TECHNOLOGIES.COM)  
[INFO@I3-TECHNOLOGIES.COM](mailto:INFO@I3-TECHNOLOGIES.COM)