



i3TOUCH E-ONE

Experience Ultimate Value.

The i3TOUCH E-ONE delivers durability, and an all-in-one integrated experience for an incredible value. With high-precision IR technology and zero air gap, the E-ONE gives you an excellent multi-touch experience.

Powered by
Android 11

55"

65"

75"

86"

i3TOUCH E·ONE

Discover the features



Experience ultimate value.

The i3TOUCH E-ONE delivers durability, and an all-in-one integrated experience for an incredible value. With high-precision IR technology and zero air gap, the E-ONE gives you an excellent multi-touch experience. Running on Android 11 and preloaded with all the interactive essentials you need – whiteboard, annotate, present, browsing and video conferencing – the i3TOUCH E-ONE is a powerful asset for your classroom or office. Using i3RDM (Remote Display Management) you can work with ease and manage the i3TOUCH E-ONE remotely.

Have a hybrid meeting or lesson? Add a camera to your setup: one of your choosing from our integration partners, or an i3CAMERA to achieve a budget-friendly video conferencing solution. Host video conferences or classes with your own software by connecting your laptop to the E-ONE with a USB-C cable. Just one cable for audio, video, power, and touch.

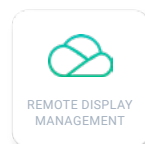
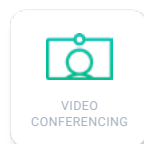
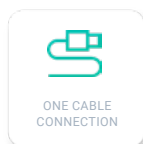
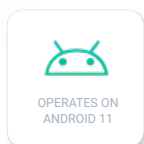

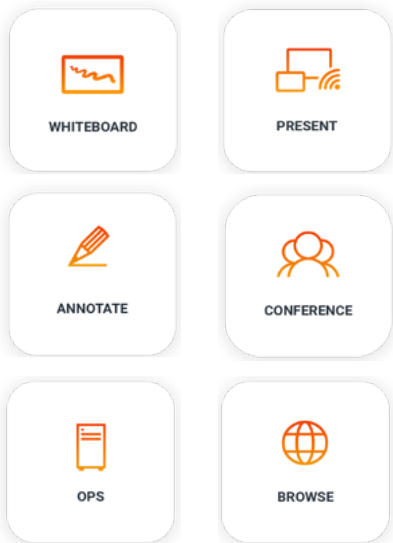

Free software included.

Our interactive displays are powered by i3STUDIO – our **free, pre-installed** software suite which includes: **whiteboard, annotate, wireless presenting, video conferencing.**

i3STUDIO gives you access to your favorite apps and internet browser with just **one** touch on the intuitive interface. With a state-of-the-art OTA (Over-The-Air) platform, you can be sure your device is always up to date with the latest firmware. All of this is included in i3STUDIO with **free updates, forever.**



Full stack for great performance

i3STUDIO is built on completely new and future-proof technical architecture with improved management capabilities including: notification and messaging system, integrated support, and OTA updates.



Go-to apps at your fingertips

The apps you rely on daily are available on i3STORE. Using the secure environment you can browse, install, update, and keep track of your apps on i3STUDIO. PowerPoint, Word, Zoom, digital signage, and more.



Free lifelong updates

Forever-free automatic updates. No subscription fees, hassle-free updates, and one seamless updating process - all Over-The-Air. You will always use the latest software version even if you bought your device years ago.

i3TOUCH E-ONE

Compatible products & accessories



i3CAMERA PRO

4K video conferencing camera with wide 120° angle, omnidirectional microphone and low light support.



i3CAIR

The i3CAIR Air Quality Sensor can monitor the air quality of your workspace or classroom and trigger alerts when rooms need to be ventilated.



i3RDM

Manage, maintain, and monitor your fleet of interactive displays from anywhere at any time.

i3TOUCH E-ONE

Product specs



Multi-function button

Define your favorite actions on a hardware button. You can set it to freeze the image, take a screenshot, switch to your preferred video input source and more.



i3STUDIO

Our interactive displays are pre-installed with i3STUDIO. i3STUDIO delivers everything you need to accomplish your best lesson, pitch, presentation or brainstorming session. Leave the room dazzled.



Just one cable

The i3TOUCH E-ONE allows devices with a USB-C connection to be connected to the screen with one cable for image, audio, touch, power (65W) and camera.



Easy Input

Enjoy the freedom of connectivity with the frontal USB-C and HDMI input slots.



Integrated Speakers

The integrated audio system pumps out loud and full-bodied sound that is capable of filling a whole room.



Multitasking

Supports split-screen mode allowing you to use two apps at the same time on your i3TOUCH E-ONE.



Natural Writing

A natural writing experience is one of our top priorities. Thanks to the zero-air gap technology we were able to achieve a pen-to-paper feeling.



Motion and light sensor

The combination of a motion and light sensor will optimize your viewing experience to all lighting conditions and keep energy consumption balanced.

DISPLAY PROPERTIES

	55"	65"	75"	86"
Model Name	i3TOUCH E-ONE 55	i3TOUCH E-ONE 65	i3TOUCH E-ONE 75	i3TOUCH E-ONE 86
Product series	i3TOUCH E-ONE Series - Interactive Digital Whiteboard Displays			
Product ID	10010352	10010354	10010353	10010352

DISPLAY SPECIFICATIONS

Display technology	IPS-ADS Liquid Crystal Display (LCD)			
Backlight technology	Direct-LED backlight			
Panel size	55"	65"	75"	86"
Display aspect ratio	16:9			
Display native resolution	3840 x 2160 pixels - 4K Ultra High Definition			
Display mode	IPS, transmissive			
Brightness (typical)	380 cd/m ²			
Brightness (maximum)	450 cd/m ²			
Contrast ratio (typical)	1200:1			
Dynamic contrast ratio	4000:1			
Viewing angle	178° / 178°			
Colour depth	1.07 billion colors (10 bit)			
Colour gamut	72% NTSC			
Response time (typ.)	8 ms			
Refresh rate	60 Hz (@ UHD)			
Surface	Antiglare, Hard coating 7H			
Supported orientation	Landscape			
Lifetime	50.000 hours			

CONNECTIVITY

Digital audio-video input	1x HDMI 2.0 incl CEC + ARC
	1x HDMI 2.0 incl CEC
	1x HDMI 2.0
Digital audio-video output	1x HDMI 2.0
Digital audio-video-data ports	1x USB 3.0 Type C, incl PowerDelivery 65W charging, Alternate Mode DP, and USB data
	1x USB 3.0 Type C, incl Alternate Mode DP, and USB data
Digital audio output	1x S/PDIF Optical
Analog video input	1x VGA
Analog audio output	3,5 mm audio jack TRS
Integrated OPS slot	OPS-PC slot (JAE TX24 connector) UHD
USB Data ports	3x USB 2.0 Type A
	2x USB 3.0 Type A
Control input	COM DE-9 (RS-232 standard)
Network connectivity	2x LAN: RJ-45 connector (1000 Mbit/sec)
	Wi-Fi 6 (802.11ax)

OPERATIONAL SPECIFICATIONS

Operating System	Android 11
Architecture	CPU : ARM A55 (4 cores)
	Clock speed : 2.3 GHz
	Cores : 4
	GPU : Mali G52 MP2
	RAM : 4 GB DDR4
	ROM : 32 GB
Interactive touch	Technology: V-SENSE Infrared Touch recognition
	Resolution : 32768 x 32768
	Accuracy : 1 mm
	Response time: 6ms (single touch), < 30ms (multitouch)
	Connection : 2x USB-B 2.0 + 2x USB-C 3.0
	Connection protocol: HID (Human Interface Device)
	Touch Points: 40 simultaneous multi-touch points
Loudspeakers	2x 16 Watt
Subwoofer	1x 16 Watt

ACCESSOIRES

Included	Quick Start Guide
	IR Remote Control Unit
	2x Passive Stylus
	Power Cable (EU, US)
	USB-C Cable (1,8m)
	HDMI 2.0 Cable
	USB 2.0 Cable A-B (TOUCH)
	Wall Mount

PHYSICAL PROPERTIES

VESA Mounting Pattern	400x200	600x400	800x400	800x600
Net Weight	28.16 kg	36.15 kg	48.45 kg	63.30 kg
Packaged Weight	39.12 kg	46.25 kg	61.85 kg	80.60 kg
Product Dimensions	1268 x 786 x 87 mm	1491 x 905 x 87 mm	1712 x 1030 x 87 mm	1959 x 1169 x 87 mm
Packaging Dimensions	1401 x 220 x 859 mm	1644 x 197 x 1046 mm	1853 x 216 x 1129 mm	2098 x 215 x 1278 mm

ELECTRICAL PROPERTIES

Input Power	100 ~ 240 Volt – 50/60 Hz			
Energy Saving Features	Auto-brightness adjustment by Ambient Light Sensor			
Power Consumption	75 Watt	82 Watt	90 Watt	148 Watt

SOFTWARE FEATURES

User Interface	i3STUDIO (Fully Customizable Launcher)
Whiteboarding Software	i3WHITEBOARD
Annotation Software	i3WHITEBOARD
Screencasting Software	i3ALLSYNC Wireless Presenting
Operating System	Android 11
Update Support	OTA (Over-the-Air)
Web Browser	Chromium
Support	Apple Airplay & Google Chromecast
Conferencing	Zoom, Teams, or browser-based
App Store	i3STORE (ability to download and install apps)
Remote Support	Ability to offer remote assistance (requires i3RDM license)

REGULATORY INFORMATION

Type Approval	CE, FCC
---------------	---------

ENVIRONMENTAL CONDITIONS

Operating Temperature	0° C to 40° C
Operating Humidity	10% to 90% RH non-condensing
Operating Maximum Altitude	5,000 meters
Storage Temperature	-20° C to 40° C
Storage Humidity	10% to 90% RH non-condensing

WARRANTY

Standard Warranty	3 years
Extended Warranty	for education entities: 5 years after registration, 7 or 8 years available for purchase for corporate entities: 5 years available for purchase



i3TOUCH E·ONE

Technical Drawings

E-ONE 55"

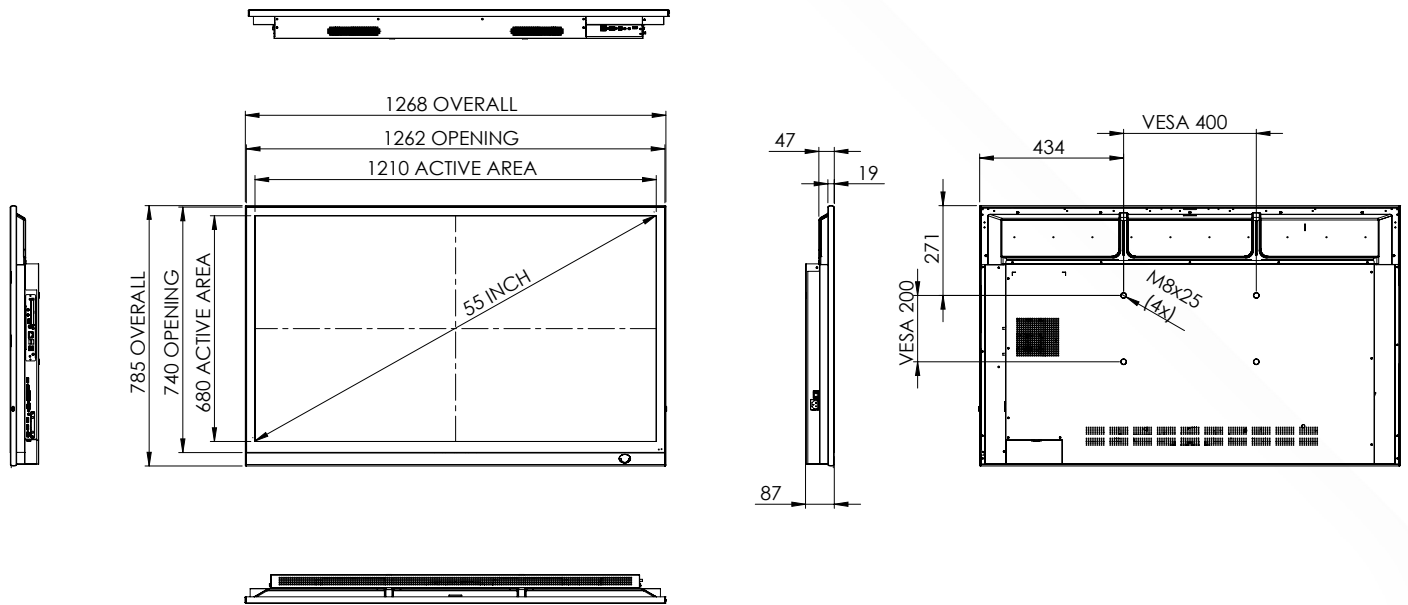

E-ONE 65"

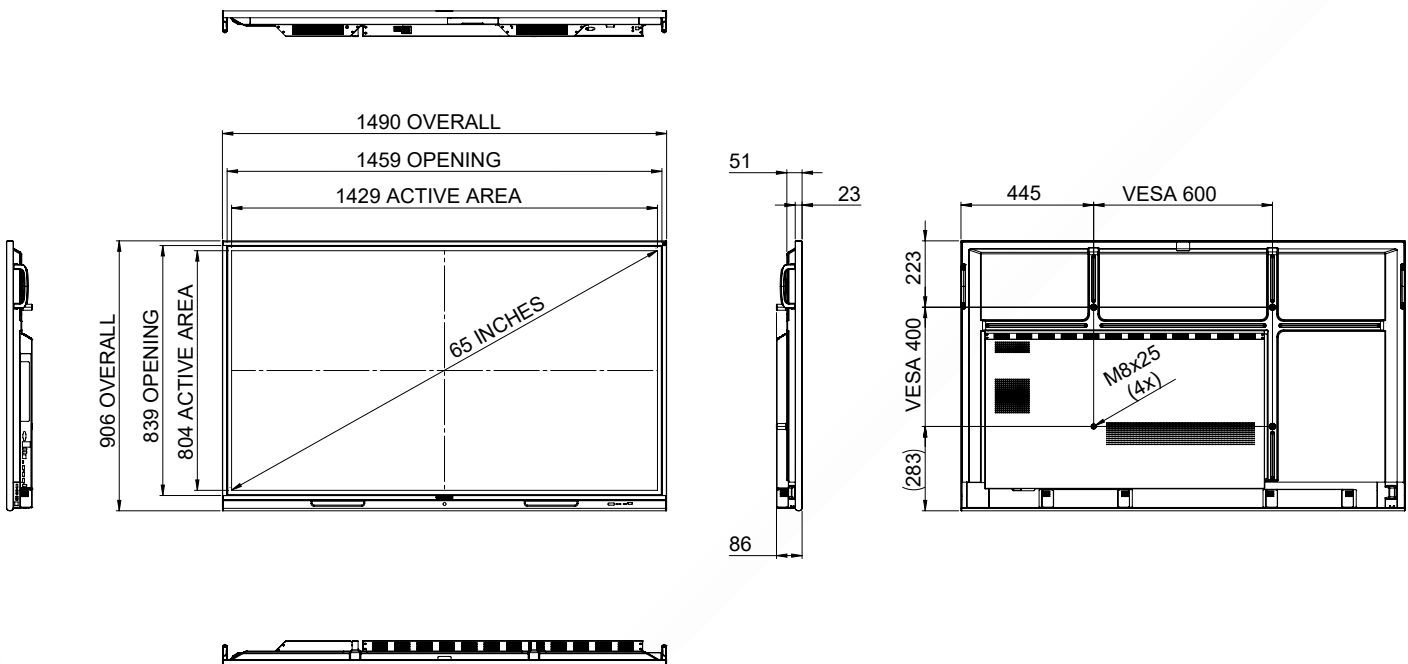

E-ONE 75"

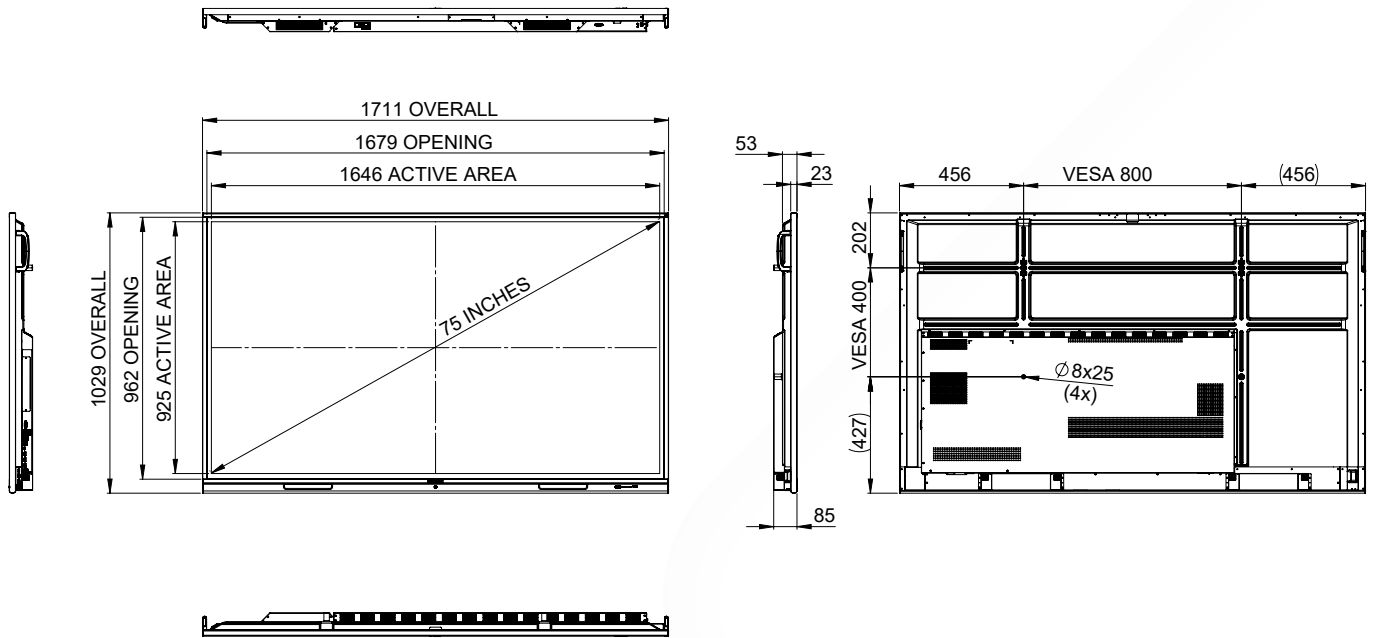

E-ONE 86"

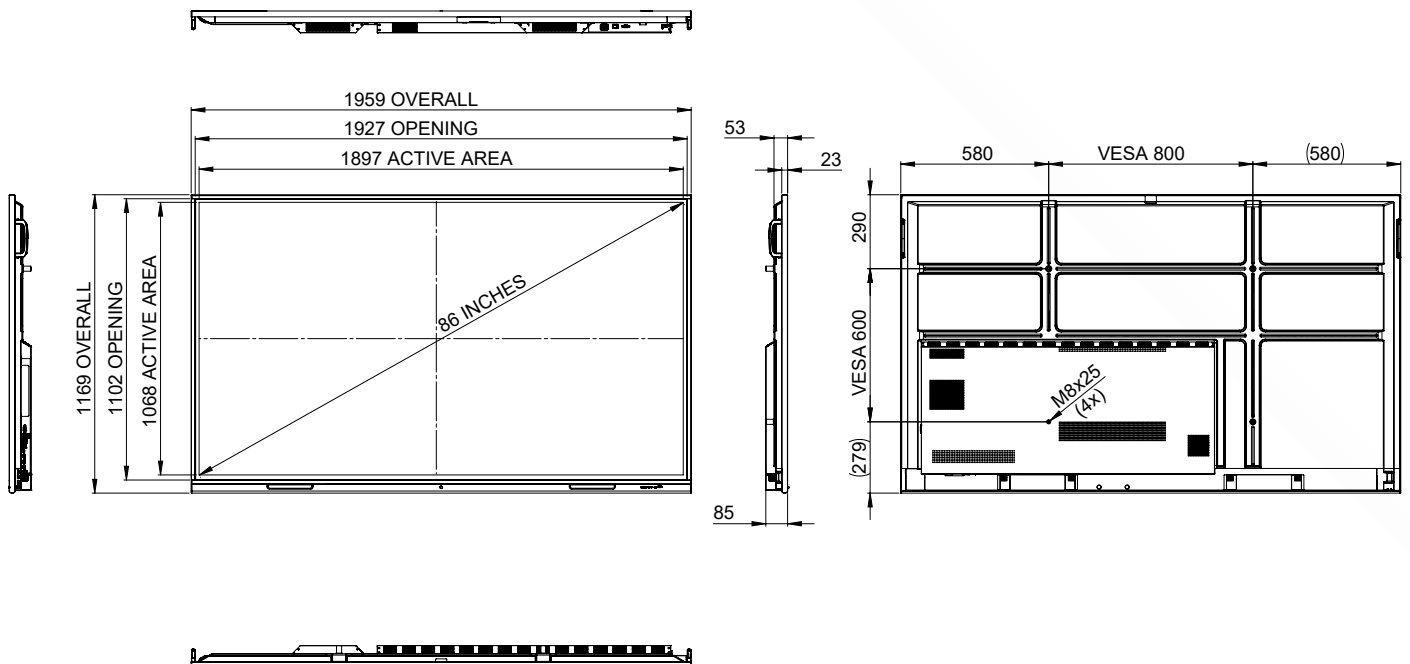

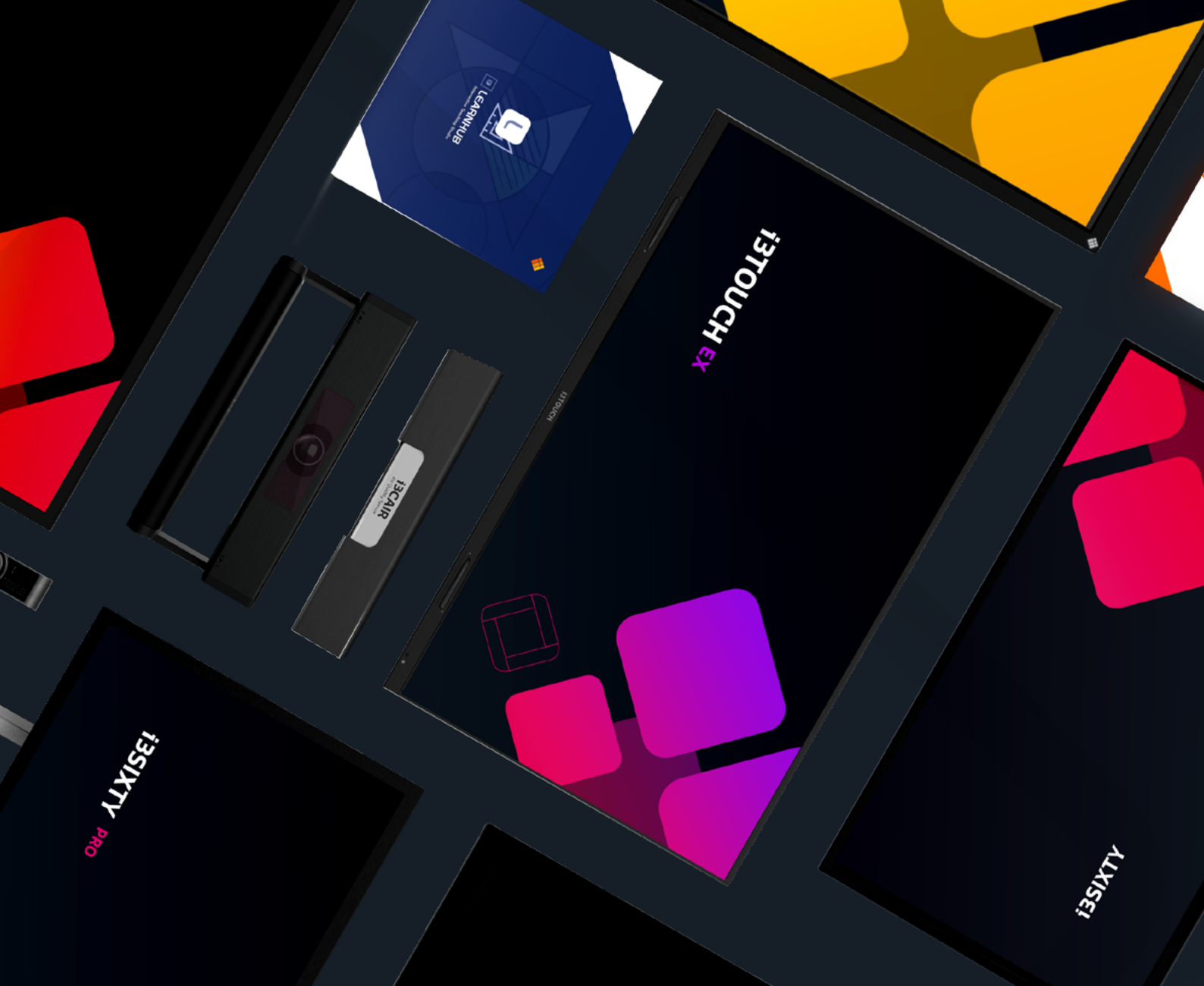

Like to know more?

i3-TECHNOLOGIES HQ

Kleine Schaluinweg 7
3290 Diest
Belgium

+32 56 31 34 15

info@i3-technologies.com



i3-TECHNOLOGIES